



COMMERCIAL
MOWERS





IMPROVING LIFE & LAWN CARE

In 1964, Hustler Turf introduced the world's first twin-lever zero-turn lawn mower. Ever since, Hustler Turf has been improving on the original design by implementing a rigorous R&D program to engineer, test, and push the envelope on what was possible with a zero-turn mower for the commercial market.

Hustler Turf is a one-stop shop for mowing professionals with sit-downs to stand-ons to walk-behinds, and deck sizes ranging from 34-inches to 104-inches.



THE HUSTLER[®] ADVANTAGE

SMOOTHTRAK™ STEERING

Developed over decades of experience. Precision control designed to help trim and maneuver easily around obstacles.



INTEGRATED PARK BRAKE

Hustler was the first to integrate the parking brake into the twin-lever design. This design was patented for years and continues to be a great safety feature for operators.



FABRICATED DECKS

Our fabricated welded-steel decks are designed to handle harsh conditions. Heavy-gauge steel and reinforced impact areas help prolong the life of the deck.



TOUGH FRAMES

Fabricated welded-steel frames, thick front axles and forks with heavy-duty caster yokes help your mower last for years. Our frames are tested for thousands of hours on concrete test tracks with inclines and embankments.



SIMPLE DESIGN

Who wants something you can't work on yourself? More engineering doesn't always mean more parts or more complexity. Quite the opposite. We engineer our mowers for easy serviceability with flip-up seat pans, removable floor pans, and vented pulley covers.



PRECISION CUT QUALITY

Our decks are not only tough, but engineered to provide a clean, crisp cut. This comes from decades of learning how the airflow inside the deck stands grass blades up during the cut. The result is an even cut and defined stripes.



COMMERCIAL MOWERS

OVERVIEW

MID-MOUNT MOWERS

STAND-ON

WALKBEHIND

FASTRAK®

FASTRAK® SDX

X-ONE®

SUPER Z®

HYPERDRIVE®

DIESEL Z

SUPER 104

SURFER PRO

SUPER S®

SUPER SF

TRIMSTAR®

OTHER PRODUCTS AVAILABLE

RESIDENTIAL MOWERS

GENERATORS AND INVERTERS

PRESSURE WASHERS



HYPERDRIVE SYSTEM

Reducing the temperature of the oil in your wheel motors is key to extending the life of your hydraulic system. Hustler's exclusive HyperDrive system helps do just that with temperature regulation and tough components designed to keep your mower at peak performance. Featuring a 5-year / 3,000-hour limited warranty** on the hydraulic system (warranty available on the HyperDrive mower only).

Available on the following mowers:

HYPERDRIVE
SUPER 104



9" Fan & High Capacity Oil Cooler with Hot Oil Shuttle



Large Oil Reservoir

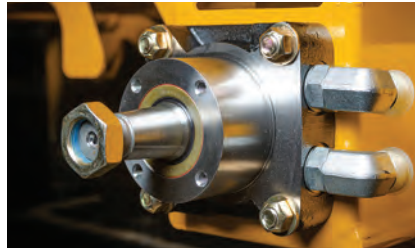

Parker Wheel Motors



Industrial-Grade Slipper Piston Pumps



Warranty available on HyperDrive mower only

**See owner's manual for warranty details and information. Certain restrictions apply.

VX™ DECK TECHNOLOGY

The Hustler VX Deck is engineered for extreme vacuum. The deck is designed to draw grass and leaves up into the mower blades helping achieve a consistent cut.

Available on the following mowers:

X-ONE Super Z
SUPER S HyperDrive
SUPER SF

1 Front Wall to Blade Distance
Opened to allow for adequate grass throughput and aid in providing even clipping dispersal.

2 Internal Front Wall Height
Designed to help grass stand back up prior to being cut.

3 Full Width Air Channel
Open across the entire front deck, designed to allow crossflow in front of the cutting chamber to aid vacuum across the width of the deck.

4 Anti-scalp Wheels
Located outside the deck to help keep the air channel unobstructed.

5 "Cut-off" Baffle
Designed to help throughput and balance of airflow through the deck.

6 "Sharp" Wrapper Intersections
Help minimize air flow across the back of the deck.

7 High Sail Blades
Helps generate lift.

8 Front of the Deck
11 ga. bull nose/ramp.



9 Blade Bolt Protectors
Helps protect the bolts from being sheared off from uneven ground or hard debris.

10 7 ga. Deckplate with 7 ga. Stamped Spindle Mounts
Designed for durability and long life in sandy conditions.



VX4® DECK TECHNOLOGY

The VX4 Deck combines four performance features to help provide a quick, clean, and professional looking cut: Versatility, Velocity, Vacuum and Volume. The combination allows professionals to move grass through the deck efficiently and consistently.

Available on the following mowers:

Super Z
HyperDrive
Diesel Z

DECK FEATURES

- 1 Formed Discharge Stiffener**
For rigidity to help movement at the discharge opening.
- 2 Deckplate Reinforcement**
7 ga. steel along the top of the deck is engineered to provide continuous support from front to back and to help prevent the deck from bending.
- 3 Stamped Deck Doublers**
Stamped 7 ga. steel around the spindle mount areas creates a 3.8" total thickness designed to support the spindle and add strength to the deck.

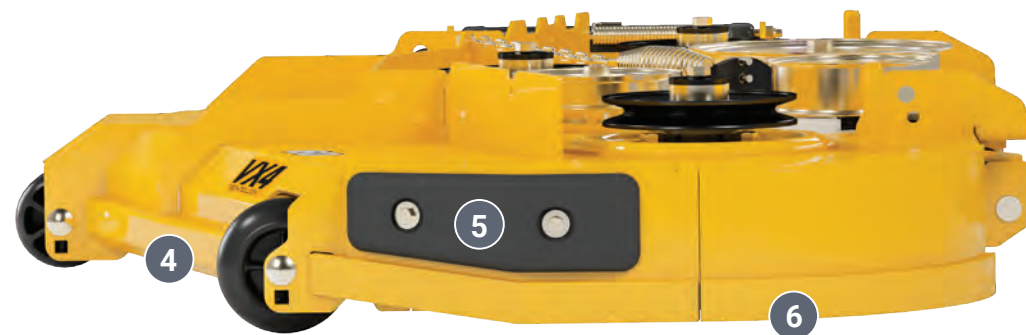

- 4 Formed Bump Bar**
Angled contact surface formed and engineered to help protect the deck by deflecting impacts.
- 5 Wear Guard**
Poly replaceable wear plate helps protect deck trim edge and obstacles from damage.
- 6 Deck Guards**
 $\frac{3}{8}$ " thick guard helps protect the integrity of the deck from side impacts.

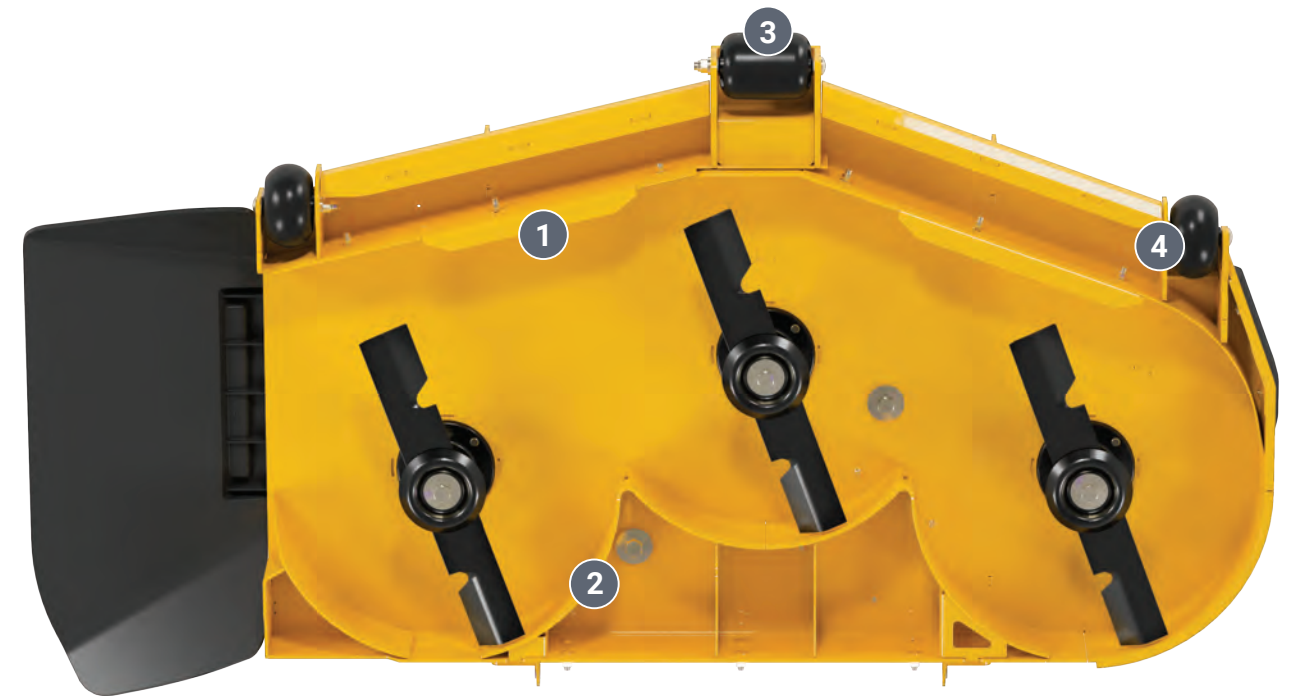

UNDERSIDE OF DECK FEATURES

- 1 Adjustable Front Baffle**
Allows for adjusting the deck according to mowing season and grass type for a precise cut.
- 2 Deck Wrappers**
7 ga. deck wrappers help fortify the deckplate.
- 3 Front Anti-Scalp Wheel**
Anti-scalp wheels with internal bushings help protect turf from scalping damage or uneven terrain.
- 4 Heavy Gauge Mounts**
 $\frac{3}{8}$ " guard helps protect the integrity of the deck from side impacts.

SPINDLE IMPROVEMENTS

- Debris Shield**
Designed to protect the top bearing from water, dirt, and debris.
- Relief Fitting**
Designed to protect seals from overpressure when filling with grease.
- Ductile Cast Iron Housing**
Helps provide protection for the spindles.
- Grease Zerk**
Easy access to grease the spindles.
- Blade Bolt Protectors**
Designed to protect the bolts from being sheared off from uneven ground or hard debris.

FASTRAK

Engine	Deck Sizes Available
22HP* - Kawasaki® FT691	48", 48" RD, 54", 54" RD
24HP* - Kawasaki FT730	60"
27HP* - KOHLER® 7500 EFI	54", 60"

RD = Rear Discharge

✓ 4yr / 750hr limited warranty**



Standard Dual USB Port



High-back Suspension Seat
High-back seat with suspension to help shield the operator from bumps and EVC cushion designed to help take pressure off the tailbone and lower back.



Commercial-Grade Kawasaki® FT Engine
With Vortical Air Filtration. Cleans debris to help extend engine life.



Dual Roto-Molded Fuel Tanks
8.5 gallon fuel capacity and dual fuel gauges.

*As rated by the engine manufacturer
**See owner's manual for warranty details and information. Certain restrictions apply.

UPGRADES FOUND ON THE FASTRAK SDX

Compared to FasTrak

Engine	Decks Sizes Available
22HP* - Kawasaki FX691	48", 54"
23.5HP* - Kawasaki FX730	60"

- ✓ **Extra High-Back Suspension Seat**
Higher backrest and more bolstered back cushion
- ✓ **Kawasaki® FX Engine**
Full commercial remote canister air cleaner
- ✓ **Larger Transmissions**
Hydro-Gear® ZT-3400™
- ✓ **More Warranty Coverage**
4yr/1000hr compared to 4yr/750hr limited warranty**



*As rated by the engine manufacturer
**See owner's manual for warranty details and information. Certain restrictions apply.

FASTRAK SERIES

FASTRAK & FASTRAK SDX SHARED FEATURES

1 Magnetic Top Pin Deck Lift System
Adjust the deck height between 1.5" -4.5" with your foot.

2 SmoothTrak™ Steering
Precision control designed to help trim and maneuver easily around obstacles.

3 Cast Deck Hangers
Designed to help improve durability.



4 Front and Rear Tie Downs
1.5" x 3" tubular steel fabricated frame with front and rear tie downs.

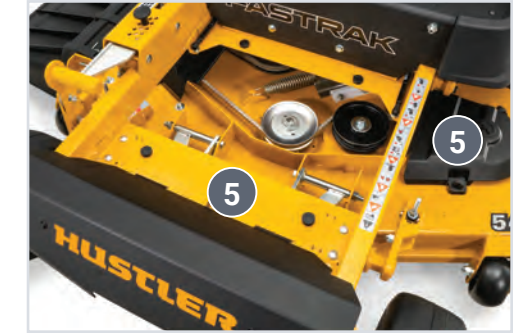
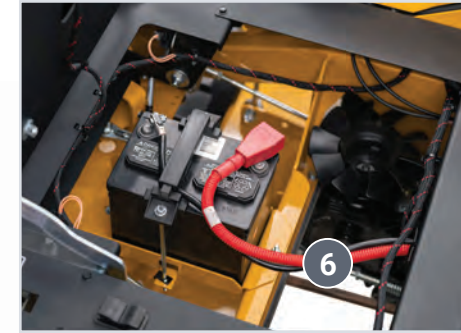

5 Easy Serviceability
Flip-up seat pan, removable floor pan, and toolless removable pulley covers to make maintenance easy and simple.

6 Less Clutter Under Seat
Provides airflow aiding in keeping transmissions cooler.

7 Transmissions
Serviceable Hydro-Gear® Transmissions.

8 Welded Steel Deck
10 ga. welded fabricated steel.

9 BigBite™ Tires
Excellent traction designed not to tear up turf. We worked directly with the tire manufacturer on this product.

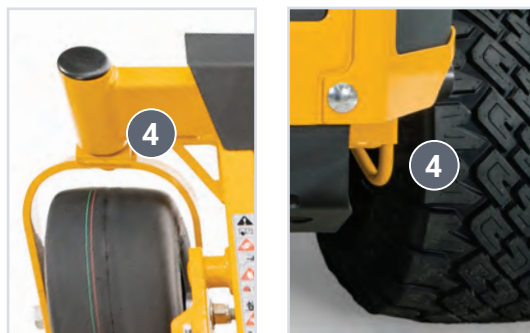

FasTrak model pictured above.

X-ONE

X-ONE

Engine	Deck Sizes Available
25HP* - KOHLER® Command Pro	52", 60"
27HP* - Kawasaki® FX850	52", 54" RD, 60", 60" RD, 72"
29.5HP* - Kawasaki FX850 EFI	60", 72"
28HP* - Vanguard® BigBlock™ w/ Oil Guard	60"

RD = Rear Discharge



✓ 5yr / 1200hr limited warranty**
(First 2 years no hour limit)



VX™ Deck
Fabricated 7 ga. steel engineered for extreme vacuum to deliver an excellent after cut appearance.



13M™ Suspension Seat
High-back seat with adjustable armrests and 3-inch travel range.



Commercial-Grade Engines
Kawasaki® FX, Vanguard® BigBlock™ w/Oil Guard, and KOHLER® Command Pro Engine options backed by 3-year limited warranties**.



1

Fabricated Frame
1.5" x 3.0" steel single piece fabricated frame.

2

SmoothTrak™ Steering
Precision control to help trim and maneuver easily around obstacles.

3

Foot Operated Deck Lift
Easily adjust the deck height between 1"- 5.5" with your foot.

4

VX Deck
Fabricated 7 ga. steel engineered for extreme vacuum for performance and cut quality.

5

Commercial-Grade Torque
Hydro-Gear ZT-4400™.

6

13M™ Seat
High-back seat with adjustable armrests and 3-inch suspension travel range.

*As rated by the engine manufacturer
**See owner's manual for warranty details and information. Certain restrictions apply.

SUPER Z

SUPER Z

Engine	Deck Sizes Available
27HP* - Kawasaki® FX850	54", 60",
35HP* - Kawasaki FX1000	60", 60" RD, 66", 72", 72" RD
38.5HP* - Kawasaki FX1000 EFI	60", 72"
40HP* - Vanguard® BigBlock™ w/ Oil Guard	60", 72"

RD = Rear Discharge

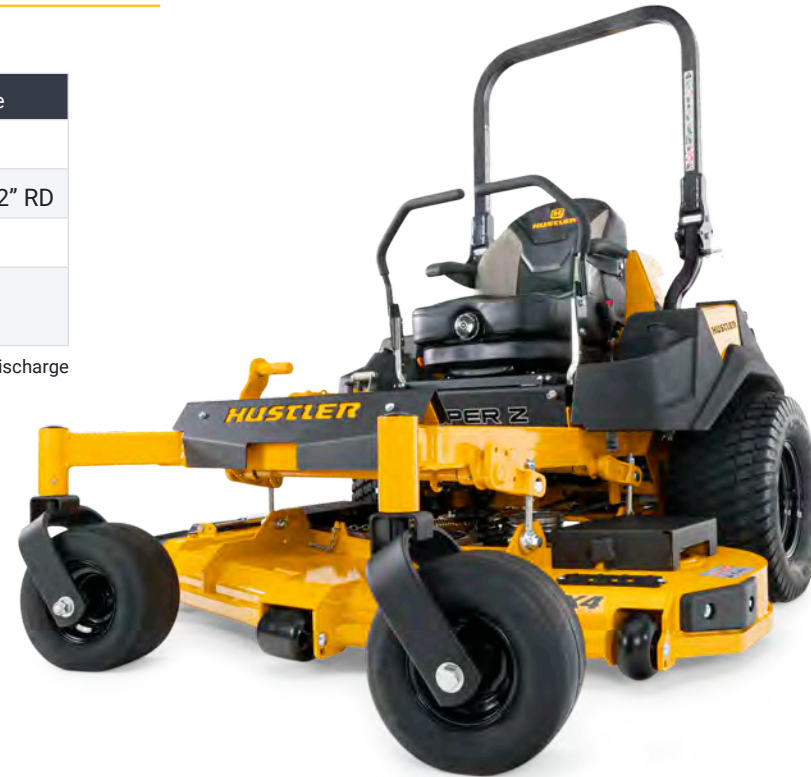

✓ 5yr / 1200hr limited warranty**
(First 2 years no hour limit)



Commercial-Grade Torque
Hydro-Gear 21cc PY pumps and Parker TG wheel motors.



Heavy-Duty Hydraulics
with 3 gal. oil reservoir, oil cooler w/ fan & hot oil shuttle.



Kawasaki FX & Vanguard Big Block EFI Engines
Kawasaki FX1000 EFI also available.

1 VX4® Deck
Fabricated 7 ga. steel deck engineered to help move grass at high speed while maintaining cut-quality.

2 Foot Operated Deck Lift
Easily adjust the deck height between 1"- 5.5" with your foot.

3 I3M™ Suspension Seat
High-back seat with adjustable armrests and 3-inch travel range.

4 SmoothTrak™ Steering
Precision control to help trim and maneuver easily around obstacles.

5 Large Fuel Capacity
Dual fuel tank w/ 12 gallon total fuel capacity.

6 Easy Serviceability
Flip-up seat pan, removable floor pan, and vented pulley covers for easy and simple maintenance.

*As rated by the engine manufacturer
**See owner's manual for warranty details and information. Certain restrictions apply.

HYPERDRIVE

HUSTLER EXCLUSIVE 

HYPERDRIVE

Engine	Deck Sizes Available
35HP* - Kawasaki® FX1000	60", 72"
40HP* - Vanguard® BigBlock EFI w/ Oil Guard	60", 72"
38.5HP* - Kawasaki FX1000 EFI	60", 60 RD", 66", 72", 72" RD

RD = Rear Discharge



5 YEAR | **3000** HOUR
PUMPS
AND
MOTORS
LIMITED WARRANTY™

✓ 5yr / 1200hr limited warranty**
(First 2 years no hour limit)



HyperDrive® Hydro System
Features industrial-grade pumps and motors to handle tough jobs and long days.



Optional Vanguard® Big Block™ Engine w/ Oil Guard
500 hour oil change.



Industrial-Grade Slipper Piston Pumps
These kinds of pumps are typically found on larger equipment like skid steers.

- 1 SmoothTrak™ Steering**
Precision control designed to help trim and maneuver easily around obstacles.
- 2 Foot Operated Deck Lift**
Easily adjust the deck height between 1" - 5.5" with your foot.
- 3 I3M™ Suspension Seat With Upholstered Armrests**
High-back seat with adjustable armrests and 3-inch travel range.
- 4 Ample Torque**
Danfoss DDC-20 pumps and Parker TG wheel motors.
- 5 VX4® Deck**
Fabricated 7 ga. steel deck engineered to help move grass at high speed while maintaining cut-quality.
- 6 Easy Serviceability**
Flip-up seat pan, removable floor pan, and vented pulley covers for easy and simple maintenance.

*As rated by the engine manufacturer

**See owner's manual for warranty details and information. Certain restrictions apply.

DIESEL Z

Engine	Deck Sizes Available
25HP* - Perkins®	60" RD, 60", 72", 72" RD

RD = Rear Discharge



✓ 5yr / 1200hr limited warranty**
(First 2 years no hour limit)



Service Access
Removable back cover for maintenance access.



I3M™ Suspension Seat
High-back seat with adjustable armrests and 3-inch travel range.



Patented Belt Drive System
Helps provide long-life to the machine.

DIESEL Z

- 1 **Formed Bump Bar**
Angled contact surface formed and engineered to protect the deck by deflecting impacts.
- 2 **Reinforced Edge**
1.5" x .375" steel bar.
- 3 **14.4 US Gallon Fuel Capacity**
- 4 **VX4® Deck**
Fabricated 7 ga. steel deck engineered to help move grass at high speed while maintaining cut-quality.
- 5 **Top Access**
Top hatch opens for access to service points.
- 6 **Filter Access**
Easy access to slide out filter.



*As rated by the engine manufacturer
**See owner's manual for warranty details and information. Certain restrictions apply.

SUPER 104

HUSTLER EXCLUSIVE ★

Engine	Deck Sizes Available
40HP* - Vanguard® BigBlock EFI w/ Oil Guard	104" RD
38.5HP* - Kawasaki® FX1000 EFI	104" RD

RD = Rear Discharge



✓ 5yr / 1200hr limited warranty**
(First 2 years no hour limit)



HyperDrive® Hydro System
Features industrial-grade pumps and motors to handle tough jobs and long days.



104" Width of Cut
Widest zero-turn available from Hustler Turf.



80" Transport Width
Fits most trailers making it easy to transport from job-to-job.

SUPER 104

1 HyperDrive® Hydro System
Features industrial-grade pumps and motors to handle tough jobs and long days.

2 SmoothTrak™ Steering
Precision control designed to help trim and maneuver easily around obstacles.

3 Hydraulic Deck Height Adjustment
Raising and lowering your cutting height is easy.

4 I3M Suspension Seat
High-back seat with adjustable armrests and 3-inch travel range.

5 Commercial-Grade Engines
Vanguard Big Block™ EFI with Oil Guard, Kawasaki FX1000 EFI engine options.

6 Hydraulic Wings
Easily raise and lower wings for transporting.



80" Transport Width
Fits most trailers making it easy to transport from job-to-job.

104" Width of Cut
Widest zero-turn available from Hustler Turf.

*As rated by the engine manufacturer
**See owner's manual for warranty details and information. Certain restrictions apply.

SURFER PRO

Engine	Deck Sizes Available
15HP* - Kawasaki® FS541	34", 48"

- ✓ 3yr / 300hr residential limited warranty**
or 2yr / 300hr commercial limited warranty**



Kawasaki FS Engine
15hp* Commercial FS541
V-Twin Engine.



Fabricated Deck
Heavy duty construction.



Ideal for Commercial Contractors and Homeowners
For tight spaces and fenced backyards with gates.

SURFER PRO

1 Semi Pneumatic Front Tires
11" front tires.

2 34" & 48" Decks
Fabricated steel decks for durability.

7 2 Gallon Fuel Capacity

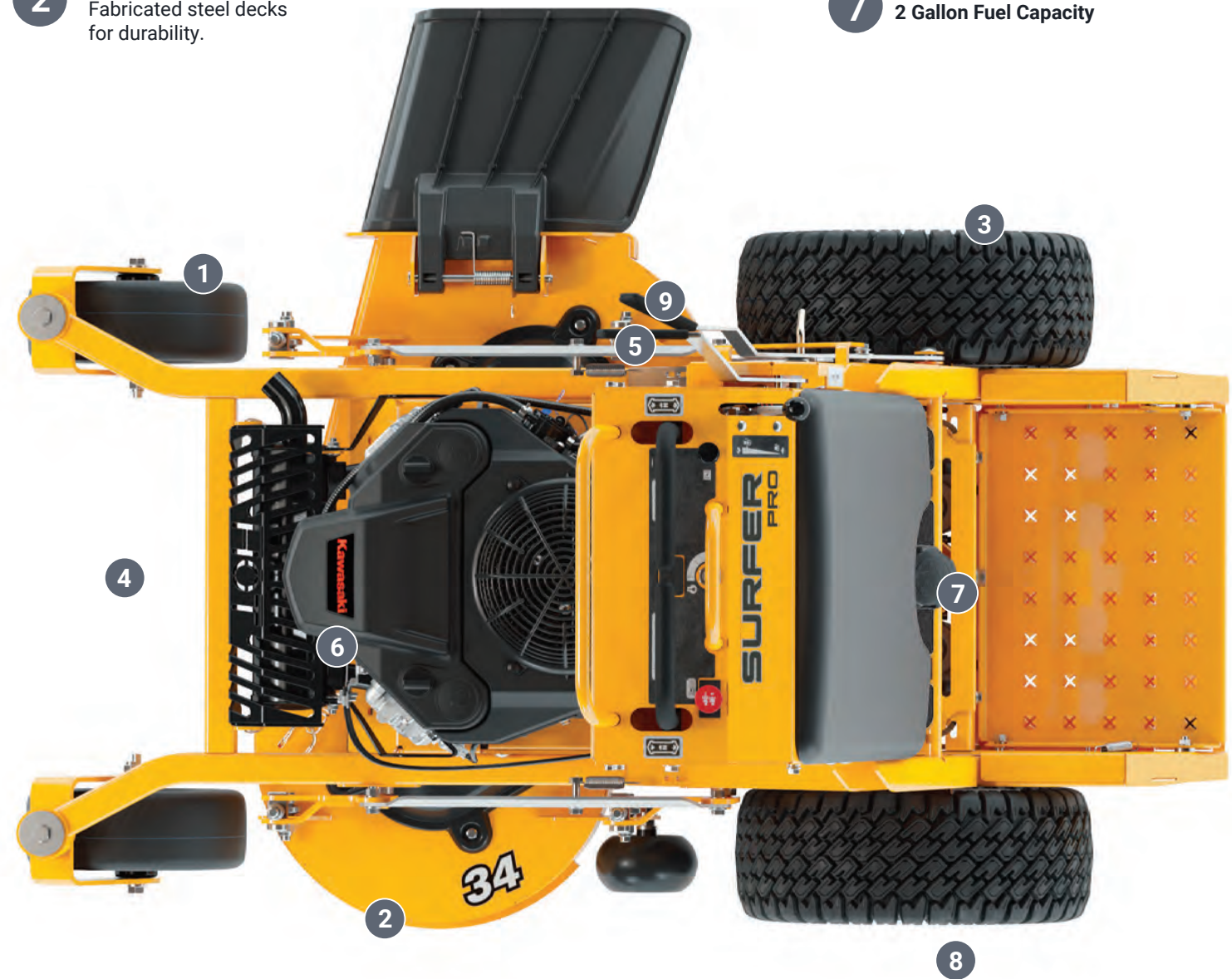

3 18" Drive Tires
Helps provide stability and traction.

5 Park Brake
Hand operated lever to set the park brake.

8 Hydro-Gear ZT-1800® Transmissions

4 Small Footprint
Just 59" in length for easy storage and trailering.

6 Kawasaki FS541 Engine
15hp*

9 Cut Height Adjustment
Hand operated lever and pin to easily adjust deck/cutting height.

*As rated by the engine manufacturer
**See owner's manual for warranty details and information. Certain restrictions apply.

SUPER S

Engine	Deck Sizes Available
15HP* - Kawasaki® FS541	36"
19HP* - Kawasaki FX600	36"
22HP* - Kawasaki FX691	48"
27HP* - Kawasaki FX850	52", 60"
29.5HP* - Kawasaki FX850 EFI	52", 60"
28HP* - Vanguard w/ Oil Guard	52"



✓ 5yr / 1200hr limited warranty**
(First 2 years no hour limit)



Compact Stance
Perfect for tight spaces and trailering from job-to-job.



VX Deck
Fabricated 7 ga. steel deck, engineered for extreme vacuum performance and cut quality.



SmoothTrak™ Steering
Precision control designed to help trim and maneuver easily around obstacles.

SUPER S

1 Pulley Covers
Toolless removable pulley covers for easy maintenance.

2 Park Brake
Hand operated lever to set the park brake.

7 24" Rear Drive Tires
For superior traction. (48", 52", 60")



3 Cut Height Adjustment
Hand operated lever and pin to adjust deck/cutting height.

5 Adjustable Foot Platform
Spring loaded suspension platform designed for all-day comfort.

4 Wide Operator Platform
For mowing comfort and operator stability.

6 Service Friendly Design
Designed to make maintenance and service fast and easy.

8 Adjustable Speed Controls
Allows you to go at your own pace for control. Also helps with training new operators.

*As rated by the engine manufacturer
**See owner's manual for warranty details and information. Certain restrictions apply.

SUPER SF

Engine	Deck Sizes Available
38.5HP* - Kawasaki® FX1000 EFI	60", 72"
40HP* - Vanguard® BigBlock EFI w/ Oil Guard	60", 72"

RD = Rear Discharge



✓ 5yr / 1200hr limited warranty**
(First 2 years no hour limit)

» Up to 15mph top speed



Strong Hydraulics

Hydro-Gear® 21cc pumps and Parker TG wheel motors



VX Deck

Fabricated 7 ga. steel deck, engineered for extreme vacuum performance and cut quality.



Dual Fuel Tanks

13.9" gal fuel capacity

1 Semi Pneumatic Front Tires
13" front tires.

2 60" and 72" VX Deck
7 ga. deckplate with 7 ga. stamped spindle mounts and 11 ga. bull nose leading edge.

7 Large Rear Tires
26" x 12" rear tires help with stability and traction.



3 Electric Actuator Deck Lift
Easily adjust your cutting height from 2.0" to 5.5".

5 Kawasaki FX EFI and Vanguard EFI Oil Guard Engine
38.5 and 40 hp* options.

4 Hydro Oil Cooler
8" fan and 6-quart reservoir capacity.

6 Service Friendly Design
Designed to make maintenance and service fast and easy.

8 Speed Control Bar Adjustment
Up to 15 mph with reduced speed up to 10 mph.

*As rated by the engine manufacturer

**See owner's manual for warranty details and information. Certain restrictions apply.

TRIMSTAR

Engine	Deck Sizes Available
15HP* - Kawasaki® FS541 (Electric Start)	36"
18.5HP* - Kawasaki FS600 (Electric Start)	48"
22HP* - Kawasaki FS651 (Electric Start)	54"
23HP* - Kawasaki FS691 (Electric Start)	60"

✓ 5yr / 1200hr limited warranty**
(First 2 years no hour limit)



Welded Steel Deck

10 ga. plus 11 ga. reinforced steel with 11 ga. formed channel rolled edge. (36 in. deck is 7 ga. plus 7 ga. reinforced steel)



Dual Hydro System

Hydro-Gear ZT-2800® transmissions aid in traction and performance.



Compact Stance

Ideal for tight spaces and for trailering from job-to-job.

TRIMSTAR



- 1 **H-Bar® Steering**
Patented, H-Bar Steering, is easy-to-use, designed to minimize operator fatigue and aid in training new operators.
- 2 **SmoothTrak™ Steering**
Precision control designed to help trim and maneuver easily around obstacles.
- 3 **3.4 US Gallon Fuel Capacity**
- 4 **Deck Lift**
Easy-to-operate deck lift makes deck height adjustment a breeze.
- 5 **Service Friendly Design**
Designed to make maintenance and service simple and easy.
- 6 **20" Drive Tires**



*As rated by the engine manufacturer
**See owner's manual for warranty details and information. Certain restrictions apply.

ACCESSORIES & OTHER PRODUCTS (each sold separately)



2-BAG POWERED BAGGER

Bagger has a 7.2-bushel capacity. Available on FasTrak® and FasTrak® SDX.



3-BAG POWERED BAGGER

Bagger has a 12-bushel capacity. Available on X-ONE®, Super Z®, and HyperDrive®.



FLEX FORKS®

Designed to provide operator comfort and an even cut, especially over uneven terrain or at high speeds.



MULCH KIT

Recycles clippings back into the soil to reclaim nutrients for your lawn.



STEEL SIDE BAGGER

Bagger has a 3.5-bushel capacity. Available on FasTrak, FasTrak SDX, X-ONE, Super S®, and TrimStar®.



MESH SIDE BAGGER

Bagger has a 3-bushel capacity. Available on FasTrak, FasTrak SDX, X-ONE, Super S, and TrimStar.



STEERING EXTENSION KIT

Allows for height adjustment of steering levers to help make your mowing experience as comfortable as possible.



LIGHT KIT

Help extend productivity into late hours. Kit contains two high-quality 12-volt lights with a switch that mounts in the instrument panel.



BACVAC

Electric actuated DFS bagger system. The BACVAC has a 10-bushel capacity. Available on X-ONE, Super Z, and HyperDrive.



MICHELIN® X® TWEEL® TURF

Airless radial tires designed to help minimize downtime caused by flat tires and unseated beads. Available on X-ONE, Super Z, HyperDrive, and Diesel Z.



STRIPE KIT

Helps provide a professional, manicured finish to your lawn. Depending on the mower, rubber flap or steel cylinder options are available.



SEMI-PNEUMATIC TIRES

Designed to help protect against flat tires.

COMPARISON

FASTRAK®



FASTRAK® SDX



X-ONE®



SUPER Z®



HYPERDRIVE®



DIESEL Z



AVAILABLE AT CERTIFIED DEALERS

SUPER 104™



AVAILABLE AT CERTIFIED DEALERS

	FASTRAK®	FASTRAK® SDX	X-ONE®	SUPER Z®	HYPERDRIVE®	DIESEL Z	SUPER 104™
CUTTING WIDTHS	48", 54" & 60" Side-discharge 48" & 54" Rear-discharge	48", 54" & 60" Side-discharge	52", 60" & 72" Side-discharge 54" & 60" Rear-discharge	54", 60", 66" & 72" Side-discharge 60" & 72" Rear-discharge	60", 66" & 72" Side-discharge 60" & 72" Rear-discharge	60" & 72" Side-discharge 60" & 72" Rear-discharge	104" Rear-discharge
ENGINE CONFIGURATIONS	Kawasaki® 22hp* FT691 24hp* FT730 KOHLER® 27hp* 7500 EFI	Kawasaki 22hp* FX691 23.5hp* FX730	Kawasaki 27hp* FX850 29.5hp* FX850 EFI KOHLER 25hp* Command Pro Vanguard® 28hp* Big Block with Oil Guard	Kawasaki 27hp* FX850 35hp* FX1000 38.5hp* FX1000 EFI Vanguard 40hp* Big Block EFI with Oil Guard	Kawasaki 35hp* FX1000 38.5hp* FX1000 EFI Vanguard 40hp* Big Block EFI with Oil Guard	Perkins® 25hp*	Kawasaki 38.5hp* FX1000 EFI Vanguard 40hp* Big Block EFI with Oil Guard
DECK HEIGHT	Foot-operated. 1.5" to 4.5" (1/4" increments)	Foot-operated. 1.5" to 4.5" (1/4" increments)	Foot-operated. 1" to 5.5" (1/4" increments)	Foot-operated. 1" to 5.5" (1/4" increments)	Foot-operated. 1" to 5.5" (1/4" increments)	Foot-operated. 1" to 5.5" (1/4" increments)	Hydraulic. 1" to 5.5" (1/4" increments)
DRIVE SYSTEM	Commercial-duty Hydro-Gear ZT-3200*. Serviceable w/ spin-on filters.	Commercial-duty Hydro-Gear ZT-3400*. Serviceable w/ spin-on filters.	Hydro-Gear ZT-4400	Hydro-Gear 21cc pumps, Parker TG high torque wheel motors, 3 gal. reservoir, oil cooler w/ fan & hot oil shuttle.	HyperDrive industrial Danfoss slipper piston pumps, Parker TG high torque wheel motors, 3 gal. reservoir, oil cooler w/ 9" fan & hot oil shuttle.	Tandem Hydro-Gear 21cc pumps, Parker TG wheel motors, oil cooler with 8" fan	HyperDrive industrial Danfoss slipper piston pumps, Parker TG high torque wheel motors, 3 gal. reservoir, oil cooler w/ 9" fan & hot oil shuttle.
SPEED (FWD)	Up to 10 mph	Up to 10 mph	Up to 12 mph	Up to 14 mph	Up to 16 mph	Up to 11.5 mph	Up to 11 mph
FUEL CAPACITY	8.5 US gallons	8.5 US gallons	Dual fuel tank with 12 US gallon total capacity.	Dual fuel tank with 12 US gallon total capacity.	Dual fuel tank with 12 US gallon total capacity.	14.4 US gallons	12 US gallons
ACCESSORIES	<ul style="list-style-type: none"> ▶ Mulch kit ▶ Dump From Seat bagger (8 bushels) ▶ Grass bagger (2-bag powered 7.2 bushels) ▶ Mesh side bagger (3 bushels) ▶ Steel side bagger (3.5 bushels) ▶ Steering lever extension kit ▶ FlexForks® ▶ Light kit ▶ Stripe kit ▶ High vacuum kit 	<ul style="list-style-type: none"> ▶ Mulch kit ▶ Dump From Seat bagger (8 bushels) ▶ Grass bagger (2-bag powered 7.2 bushels) ▶ Mesh side bagger (3 bushels) ▶ Steel side bagger (3.5 bushels) ▶ Steering lever extension kit ▶ FlexForks® ▶ Light kit ▶ Stripe kit ▶ High vacuum kit 	<ul style="list-style-type: none"> ▶ Semi pneumatic front tires ▶ Steering lever extension kit ▶ Deck rear anti-scalp wheels ▶ 3-bag powered bagger (12 bushels) ▶ BacVac bagger (10 bushels) ▶ Mesh side bagger (3 bushels) ▶ Steel side bagger (3.5 bushels) ▶ Flex Forks® ▶ Mulch kit ▶ Light kit ▶ Stripe kit ▶ Electric deck lift ▶ Hitch kit ▶ Michelin® X® Tweel® Turf 	<ul style="list-style-type: none"> ▶ Semi pneumatic front tires ▶ Steering lever extension kit ▶ Deck rear anti-scalp wheels ▶ 3-bag powered bagger (12 bushels) ▶ BacVac bagger (10 bushels) ▶ Flex Forks® ▶ Mulch kit ▶ Light kit ▶ Sand kit ▶ Stripe kit ▶ Beacon kit ▶ Flasher kit ▶ Electric deck lift ▶ Hitch kit ▶ Michelin® X® Tweel® Turf 	<ul style="list-style-type: none"> ▶ Semi pneumatic front tires ▶ Steering lever extension kit ▶ Deck rear anti-scalp wheels ▶ 3-bag powered bagger (12 bushels) ▶ BacVac bagger (10 bushels) ▶ Flex Forks® ▶ Mulch kit ▶ Light kit ▶ Sand kit ▶ Stripe kit ▶ Beacon kit ▶ Flasher kit ▶ Electric deck lift ▶ Hitch kit ▶ Michelin® X® Tweel® Turf 	<ul style="list-style-type: none"> ▶ Semi pneumatic front tires ▶ Steering lever extension kit ▶ Single/dual anti-scalp wheels ▶ Flex Forks® ▶ Mulch kit ▶ Light kit ▶ Sand kit ▶ Stripe kit ▶ Beacon kit ▶ Flasher kit ▶ Electric deck lift ▶ Hitch kit ▶ Michelin® X® Tweel® Turf 	<ul style="list-style-type: none"> ▶ Semi pneumatic front tires ▶ Steering lever extension kit ▶ Flex Forks® ▶ Mulch kit ▶ Light kit ▶ Beacon kit ▶ Flasher kit ▶ Hitch kit ▶ Anti-scalp kit

*As rated by the engine manufacturer. Specifications are subject to change without notice.

COMPARISON

SURFER PRO



SUPER S®



SUPER SF



TRIMSTAR®



CUTTING WIDTHS	34" & 48" Side-discharge	36", 48", 52", & 60" Side-discharge	60" & 72" Side-discharge	36", 48" 54" & 60" Side-discharge
ENGINE CONFIGURATIONS	Kawasaki 15hp* FS541	Kawasaki 15hp* FS541 22hp* FX691 19hp* FX600 27hp* FX850 29.5hp* FX850 EFI Vanguard® 28hp* Big Block with Oil Guard	Kawasaki 38.5hp* FX1000 EFI Vanguard 40hp* Big Block EFI with Oil Guard	Kawasaki 15hp* FS541 18.5hp* FS600 22hp* FS651 23hp* FS691
DECK HEIGHT	Hand-operated. 2" to 4.75" (1/4" increments)	Hand-operated. 1.5" to 5.5" (1/4" increments)	Hand-operated. 2" to 5.5" (1/4" increments)	Hand-operated. 1.5" to 4.5" (1/4" increments)
DRIVE SYSTEM	Hydro-Gear ZT-1800	36" : Hydro-Gear 10cc pump and Parker TL wheel motor. 48/52/60" : Hydro-Gear 12cc pump and Parker TL wheel motor.	Hydro-Gear 21cc pumps and Parker TG wheel motors	Hydro-Gear ZT-2800® w/ spin-on filters.
SPEED (FWD)	Up to 6 mph	36" : Up to 8 mph 48/52/60" : Up to 9 mph	Up to 15 mph	Up to 6.3 mph
FUEL CAPACITY	2.0 US gallons	36" : 6.5 US gal. 48/52/60" : 7.3 US gal.	13.9 US gallons	3.4 US gallons
ACCESSORIES	<ul style="list-style-type: none"> ▶ Mulch kit ▶ Mesh side bagger (3 bushels) ▶ Light Kit ▶ Stripe kit 	<ul style="list-style-type: none"> ▶ Mulch kit ▶ Mesh side bagger (3 bushels) ▶ Steel side bagger (3.5 bushels) ▶ Light kit ▶ Stripe kit ▶ Trash basket ▶ Cup holder 	<ul style="list-style-type: none"> ▶ Mulch kit ▶ Mesh side bagger (3 bushels) ▶ Stripe kit ▶ Mud Flap kit ▶ Light kit 	<ul style="list-style-type: none"> ▶ Mulch kit ▶ Mesh side bagger (3 bushels) ▶ Steel side bagger (3.5 bushels) ▶ Stripe kit ▶ High vacuum kit

*As rated by the engine manufacturer. Specifications are subject to change without notice.



HUSTLER FLUID PRODUCTS

Hustler Turf's motor oil, fuel stabilizer and hydrostatic transmission oil products will help keep your machine running smoothly. Ask your local dealer about availability of these products.

Visit [hustlerturf.com](https://www.hustlerturf.com) for more specs.

Visit [hustlerturf.com/find-a-retailer](https://www.hustlerturf.com/find-a-retailer) to locate your nearest dealer.

FLEET PROGRAM

The Hustler fleet program is one of the most aggressive in the industry. We value loyalty and reward our customers for it. To qualify you only need to purchase 2 units.

Once you're in the program, your fleet pricing is good for a rolling 12 months. If you need to add a single unit 6 months from your original purchase, you get the fleet discount for that 1 unit and your 12 months starts over.



— THE —
HUSTLER
MENTALITY

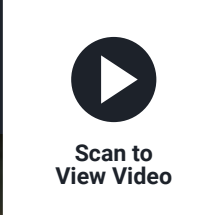

# of Units Purchased	Fleet Discount
2 Units	25% off MSRP
4 or More Units	27% off MSRP

Eligibility:

Customers who purchase 2 or more eligible products on the same invoice.

Eligible Units:

- FasTrak (2021 model and newer)
- FasTrak SDX
- X-ONE
- Super Z
- Super Z HyperDrive
- Hustler Diesel Z
- TrimStar
- Super S
- Super 88
- Super 104*
- Super SF
- Surfer Pro**

Details & Guidelines:

- If you purchase an additional eligible unit within 12 months of the original invoice date, the same rebate % originally paid per unit will be applied.
- You can continue to extend your fleet discount with purchase of at least one eligible unit during each subsequent 12-month period.
- This additional sale does not increase the original # of units sold. You retain your original bracket discount, subject to current published MSRP at the time of additional sale.
- Retail financing may be used unless otherwise stated in program.
- Programs cannot be used in conjunction with other rebates or promotions unless specifically stated.

*max discount on Super 104 is 25%
**Will count toward fleet program minimum but not eligible for discount pricing



HUSTLER®

KAWASAKI IS A REGISTERED TRADEMARK OF KAWASAKI HEAVY INDUSTRIES, LTD
KOHLER IS A REGISTERED TRADEMARK OF KOHLER CO
VANGUARD IS A REGISTERED TRADEMARK OF BRIGGS & STRATTON CORPORATION
MICHELIN IS THE REGISTERED TRADEMARK OF MICHELIN & CIE
HYDRO-GEAR IS A REGISTERED TRADEMARK OF HYDRO-GEAR LTD

©2023 HUSTLER TURF EQUIPMENT

SPECIFICATIONS SUBJECT TO CHANGE WITHOUT NOTICE.
VISIT WWW.HUSTLERTURF.COM FOR THE MOST
CURRENT SPECIFICATIONS. 773-10444 | 11-22

HUSTLERTURF.COM

